

As a global company, we offer our products and support worldwide.

The LR Series conforms to international standards. The PATLITE group has built a global sales network to effectively provide goods and services to customers anywhere.

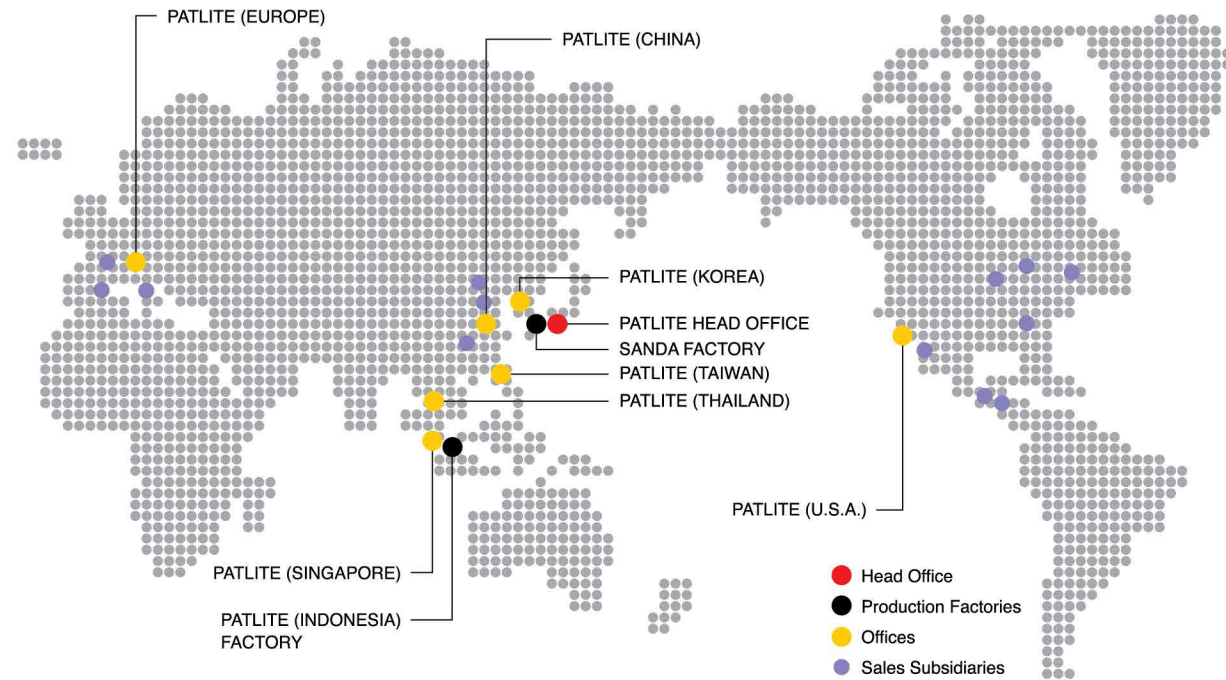

PATLITE Corporation

4-1-3, Kyutaromachi, Chuo-ku, Osaka 541-0056 Japan
TEL. +81-6-7711-8953 FAX. +81-6-7711-8961 E-mail: overseas@patlite.co.jp

PATLITE (U.S.A.) Corporation

20130 S. Western Ave. Torrance, CA 90501, U.S.A.
TEL. +1-310-328-3222 FAX. +1-310-328-2676 E-mail: sales@patlite.com

PATLITE (SINGAPORE) PTE LTD

No.2 Leng Kee Road, #05-01 Thye Hong Centre, Singapore 159086
TEL. +65-6226-1111 FAX. +65-6324-1411 E-mail: sales@patlite.com.sg

PATLITE (CHINA) Corporation

Room 1102-1103, No.55, Lane 777, Guangzhong Road (West), Zhabei District, Shanghai, China 200072
TEL. +86-21-6630-8969 FAX. +86-21-6630-8938 E-mail: sales@patlite.cn

PATLITE Europe GmbH

Am Soeldnermoos 8, D-85399 Hallbergmoos, Germany
TEL. +49-811-9981-9770-0 FAX. +49-811-9981-9770-9 E-mail: info@patlite.eu

PATLITE KOREA CO., LTD.

A2603, Daesung, D-POLIS, 606, Seobusaet-gil, Geumcheon-gu, Seoul, 08504, Korea
TEL. +82-2-523-6636 FAX. +82-2-861-9919 E-mail: sales@patlite.co.kr

PATLITE TAIWAN CO., LTD.

7F. No. 91, Huayin St, Datong District Taipei, Taiwan R.O.C
TEL. +886-2-2555-1611 FAX. +886-2-2555-1621 E-mail: info@patlite.tw

PATLITE (THAILAND) CO., LTD.

Olympia Thai Tower, 15th Floor 444 Ratchadapisek Road Samsennok, Huay Kwang Bangkok 10310, Thailand
TEL. +66-2-541-5431 FAX. +66-2-541-5429 E-mail: sales@patlite.co.th

<http://www.patlite.com>

●PATLITE, the PATLITE logo are either registered trademarks or trademarks of PATLITE Corporation in JAPAN and/or other countries.

CAUTION

To ensure correct use of these products, read the "Instruction Manual" prior to use. Failure to follow all safeguards can result in fire, electric shock, or other accidents. Specifications are subject to change without notice.



PATLITE ECO PROJECT
For the benefit of mankind and the earth, Patlite is committed to developing environmentally friendly products.

O-AG11 EN 1710 A

PATLITE®
New Frontiers in Safety, Security and Comfort.

Signal Tower LR Series

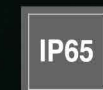

NEMA Type 4X, 13 360° Buzzer Modular

www.patlite.com

Signal Tower

LR Series

Modular LED Signal Tower

- φ 40mm LR4
- φ 50mm LR5
- φ 60mm LR6
- φ 70mm LR7



A Uniform 360° Light-Emitting Design

The new LED color module features a new, unique interior lens construction that achieves a fuller, more uniform 360° degree light output. Light color is vibrant with more emission area for reliable indication from further distances.

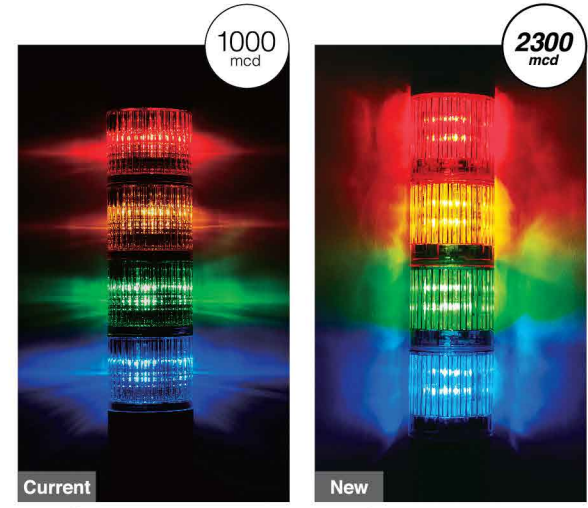

More than Twice the Light Output *

The LR Series lens distributes light more efficiently, increasing luminous intensity by more than double that of our current models.

* Based on the φ60 Red LED Model

Unique Method of Fully Enclosed Sound Module

Inspired by a drum percussion instrument, the fully enclosed sound module is able to more efficiently vibrate sound waves, producing even 360° omnidirectional sound resonance. Resistance to water and dust is also increased.

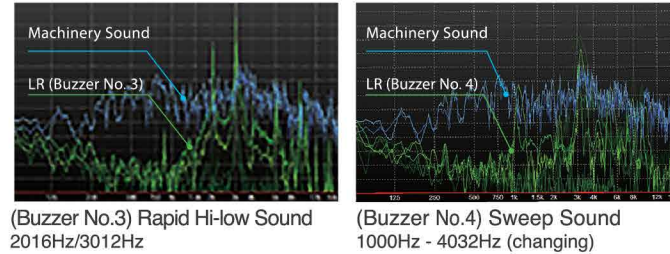
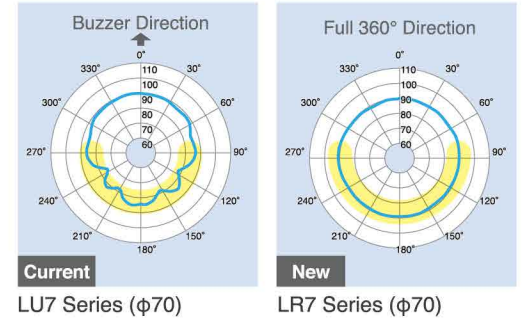

New Sounds Heard Above the Noise

1 Alarm available, (2 or more available by special order) from 4 built-in buzzer sounds. Buzzer sounds No. 3 and No. 4 are designed at a higher variable frequency to be heard above the noise of surrounding machinery. Alternatively, a sound reduction function of approx. -10dB is included for use in quieter environments.

* Four Buzzer Sounds

- No.1 Rapid Intermittent sound
- No.2 Continuous sound
- No.3 Rapid Hi-low
- No.4 Sweep sound

Maximum 90dB* Output

The fully enclosed buzzer module produces more efficient sound, up to 90dB, at 1 meter.

*LR7 buzzer No.4 (Sweep tone)



Modular System Design

Traditional stack lights typically require additional threaded shafts or tools to reconfigure LED units. The LR modular system design redefines signal tower assembly by making customization and repair seamless.



Reorganizing Modules is Effortless

The LR modular system makes reconfiguring the color order simple with its twist-and-lock design. Replacing and reconfiguring LED units or adding a buzzer module is easier than ever.

Scan to see this in action



Smooth Surface

The LR base, LED units and buzzer modules secure together tight and flush, creating a smooth surface, ideal for easy cleaning and water run off.



Environmental Performance

Features a rugged structure with the following ratings: IP65 / NEMA Type 4x, 13 withstands various environmental conditions, such as water and dust.



Upgraded Materials

Upgrading from an ABS to Polycarbonate material, and silicon resin O-rings, results in a more lightweight, shock and water resistant product.



New Lineup

Clear-globe LED Unit

LR4-E-RZ

- 4 (φ40) R (Red)
- 5 (φ50) Y (Amber)
- 6 (φ60) G (Green)
- B (Blue)

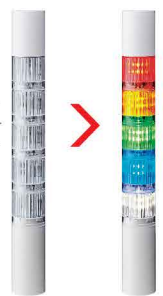

Individual Unit
Pre-assembled*
* LR4, LR6 Only

LR4 LR5 LR6

Clear globes for R,Y,G,B

Multi-color LED Unit

LR6-E-MZ

7 colors



LR6

Individual Unit
It displays 7 colors in one unit.
(Red/Green/Blue/Amber/
Cyan/Purple/White)

Wire Color	Red	Red/ Green	Blue	Green	Blue/ Green	Red/ Blue	Red/ Green/ Blue
LED Color	Red	Amber	Blue	Green	Cyan	Purple	White

Direct Mount with M12 Connector

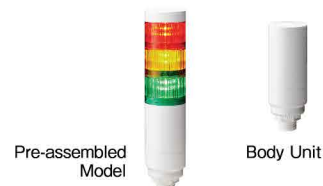

Model	Tiers	Rated Voltage	Mounting/Wiring	Buzzer	Body Color	LED Unit Color
LR 6 -	3	02	WC	N	W	RYG

Unit Model (Body Unit)	Rated Voltage	Mounting/Wiring	Buzzer	LED Unit Color
LR 6 -	02	WC	N	W

LED Color: R (Red) / Y (Amber) / G (Green) / B (Blue) / C (White) (From top to bottom)

Direct Mount Installation

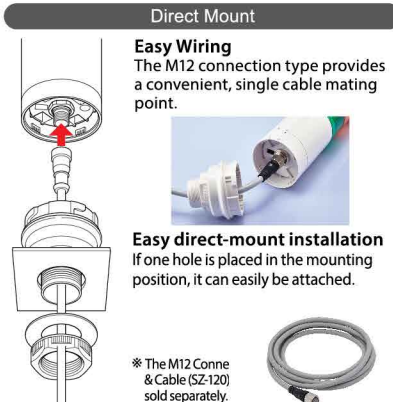

Installation Method 2

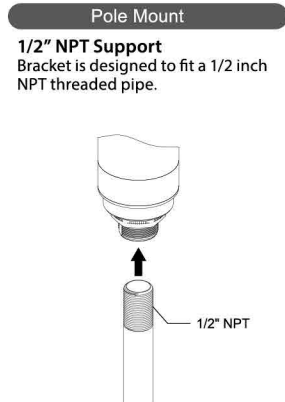

Manual Control Signal Tower

HSST-3M2-RYG



Assembly Process

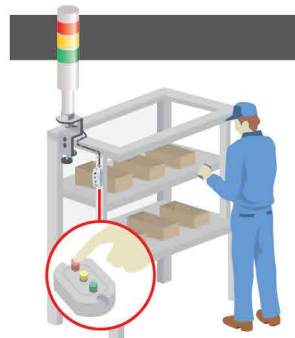

What is HSST?

It is a kit featuring an LR5 Signal Tower, a switch box, AC/DC adaptor, and mounting hardware. This system can be used for a wide range of applications such as, improving efficiency of production assembly lines and discreet communications in call centers.

Assembly Line Lighting Display Example

- Problem Occurred
- Low Material Stock
- Need Assistance

Customer Support / Call Center



Call Status Display
■ Need a Manager
■ On Hold
■ On Call

Visit bit.ly/HSST50mm for more information

Rated Voltage	Size	Operating Specifications	Tiers	Model	Color
100V - 240V AC	φ50	Switch ON/OFF Lighting Control	3	HSST-3M2-RYG	Clear

Wireless Data Acquisition System

Transmitters



Signal Tower LR6 Transmitter
WDT-6LR-Z2

Corresponding Model
LR6 Series

Current Consumption
max.55mA

Transmission Distance
20m^{#2}



Signal Tower LR5 Transmitter
WDT-5LR-Z2

Corresponding Model
LR5 Series

Current Consumption
max.55mA

Transmission Distance
20m^{#2}

Receiver



Receiver
WDR-LE-Z2

Number of Transmitters
20 Units^{#1}
MAX 30 Units

Connection Type
LAN/USB

Transmission Distance
typ.65mA

Multiple Units^{#3}

- *1 Radio signal quality will depend on the environment, device location and number of connections.
- *2 Due to the characteristic of radio waves, the connection distances are reference values.
- *3 Two or more receiver units can operate simultaneously with LAN connections.
(Ask your PATLITE Sales Representative for details.)

Monitor and Acquire Critical Equipment Data

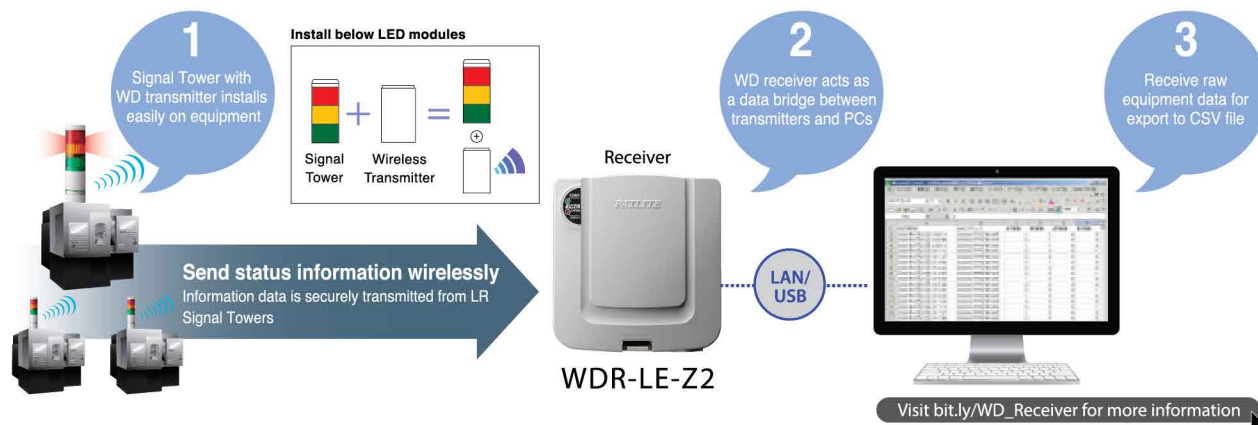

LR5/LR7 Screwless Terminal Direct Mount

Dual mount base unit allows for direct or pole mounting



Installation Kit Included.

Accessories			
LR5 - KT	Hexagon Bolt (M3 x 20)	Hexagon Nut with Flange (M3)	3 pcs.
LR7 - KT	Hexagon Bolt (M4 x 20)	Hexagon Nut with Flange (M4)	6 pcs.

Installation Method 1

Direct Mount
Knock out holes, insert hexagonal bolts, secure with nuts.

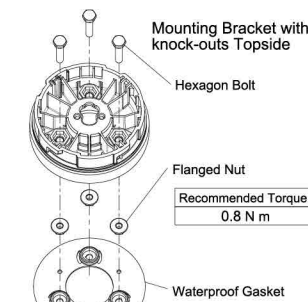

Installation Method 2

Pole Mount
Insert waterproof ring on pole, align holes on pole with holes in bracket, secure pole with self-tapping screw.

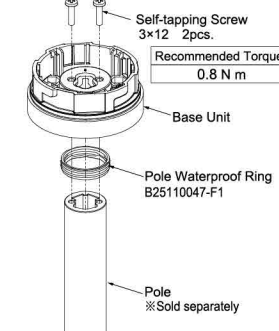

*Please refer to the Complete Operation Manual for installation details.

Signal Tower

LR Series Pre-assembled Models

φ40mm Model Code

(Ex.) **LR4-502WJBW-RYGBCZ**

Model ① ② ③ ④ ⑤ ⑥ ⑦

① Tiers ② Rated Voltage ③ Mounting/Wiring ④ Flashing/Buzzer ⑤ Body Color ⑥ LED Module Color ⑦ Globe Type

1 = 1 Tier 02 = 24V DC WJ = Direct Mount/Cable B = With Flashing/Buzzer W = Off-white R = Red Blank = Color Globe
 2 = 2 Tiers M2 = 100 - 240V AC *1 LJ = Pole Mount with L-bracket/Cable N = No Flashing/Buzzer U = Silver *3 Y = Amber Z = Clear Globe
 3 = 3 Tiers PJ = Pole Mount with Circular Bracket/Cable G = Green
 4 = 4 Tiers QJ = Pole Mount with Folding Bracket/Cable *2 B = Blue
 5 = 5 Tiers C = White

*1 For WJ, LJ (no CE), and PJ type only. *2 For 24V DC and Off-white type only *3 For 24V DC type WJ, LJ and PJ type only

φ50mm Model Code

(Ex.) **LR5-502WJBW-RYGBCZ**

Model ① ② ③ ④ ⑤ ⑥ ⑦

① Tiers ② Rated Voltage ③ Mounting/Wiring ④ Flashing/Buzzer ⑤ Body Color ⑥ LED Module Color ⑦ Globe Type

1 = 1 Tier 01 = 12V DC WJ = Direct Mount/Cable B = With Flashing/Buzzer W = Off-white R = Red Blank = Color Globe
 2 = 2 Tiers 02 = 24V DC LJ = Pole Mount with L-bracket/Cable N = No Flashing/Buzzer U = Silver *3 Y = Amber Z = Clear Globe
 3 = 3 Tiers PJ = Pole Mount with Circular Bracket/Cable G = Green
 4 = 4 Tiers QJ = Pole Mount with Circular Bracket/Cable B = Blue
 5 = 5 Tiers WC = Pole Mount with Circular Bracket/Cable M = Multi Color *4 C = White

φ60mm Model Code

(Ex.) **LR6-502WJBW-RYGBCZ**

Model ① ② ③ ④ ⑤ ⑥ ⑦

① Tiers ② Rated Voltage ③ Mounting/Wiring ④ Flashing/Buzzer ⑤ Body Color ⑥ LED Module Color ⑦ Globe Type

1 = 1 Tier 02 = 24V DC WJ = Direct Mount/Cable B = With Flashing/Buzzer W = Off-white R = Red Blank = Color Globe
 2 = 2 Tiers M2 = 100 - 240V AC *1 LJ = Pole Mount with L-bracket/Cable N = No Flashing/Buzzer U = Silver *3 Y = Amber Z = Clear Globe
 3 = 3 Tiers PJ = Pole Mount with Circular Bracket/Cable G = Green
 4 = 4 Tiers QJ = Pole Mount with Folding Bracket/Cable *2 B = Blue
 5 = 5 Tiers WC = Direct Mount/M12 Connector *2 M = Multi Color *4 C = White

*1 For WJ, LJ (no CE), and PJ type only. *2 For 24V DC and Off-white type only *3 For 24V DC type WJ, LJ and PJ type only
 *4 M is only available as MZ (with clear lens), and MZ type is only available as pre-assembled with 1 tier.

φ70mm Model Code

(Ex.) **LR7-502WJBW-RYGBC**

Model ① ② ③ ④ ⑤ ⑥

① Tiers ② Rated Voltage ③ Mounting/Wiring ④ Flashing/Buzzer ⑤ Body Color ⑥ LED Module Color

1 = 1 Tier 02 = 24V DC WJ = Direct Mount/Cable B = With Flashing/Buzzer W = Off-white R = Red
 2 = 2 Tiers N = No Flashing/Buzzer Y = Amber
 3 = 3 Tiers G = Green
 4 = 4 Tiers B = Blue
 5 = 5 Tiers C = White

Mounting Type	Rated Voltage	Size	Flash/Buzzer	Tiers	Model	Power Consumption	Mass
 <p>Pole Mount with Folding Bracket</p> <p>Standard Parts Included: 300mm Pole POLE22-0300AN Folding Bracket SZQ-001W Waterproof Ring B25110047-F1</p>	24V DC	φ40	-	1	LR4-102QJNW	1.0W	0.455kg
				2	LR4-202QJNW	2.0W	0.490kg
				3	LR4-302QJNW	3.0W	0.525kg
				4	LR4-402QJNW	4.0W	0.560kg
				5	LR4-502QJNW	5.0W	0.595kg
				1	LR4-102QJBW	2.0W	0.490kg
				2	LR4-202QJBW	3.0W	0.525kg
				3	LR4-302QJBW	4.0W	0.560kg
				4	LR4-402QJBW	5.0W	0.595kg
				5	LR4-502QJBW	6.0W	0.630kg
		φ60	-	1	LR6-102QJNW	1.0W	0.520kg
				2	LR6-202QJNW	2.0W	0.580kg
				3	LR6-302QJNW	3.0W	0.640kg
				4	LR6-402QJNW	4.0W	0.700kg
				5	LR6-502QJNW	5.0W	0.760kg
				1	LR6-102QJBW	2.0W	0.580kg
				2	LR6-202QJBW	3.0W	0.640kg
				3	LR6-302QJBW	4.0W	0.700kg
				4	LR6-402QJBW	5.0W	0.760kg
				5	LR6-502QJBW	6.0W	0.820kg

Mounting Type	Rated Voltage	Size	Flash/Buzzer	Tiers	Model	Power Consumption	Mass	
 <p>Direct Mount</p>	12V DC	φ50	-	1	LR5-101WJNW	1.0W	0.240kg	
				2	LR5-201WJNW	2.0W	0.280kg	
				3	LR5-301WJNW	3.0W	0.320kg	
				4	LR5-401WJNW	4.0W	0.360kg	
				5	LR5-501WJNW	5.0W	0.400kg	
				1	LR5-101WJBW	2.1W	0.290kg	
				2	LR5-201WJBW	3.1W	0.330kg	
				3	LR5-301WJBW	4.1W	0.370kg	
				4	LR5-401WJBW	5.1W	0.410kg	
				5	LR5-501WJBW	6.1W	0.450kg	
	24V DC	φ40	-	1	LR4-102WJNW[U]	1.0W	0.205kg/0.355kg	
				2	LR4-202WJNW[U]	2.0W	0.240kg/0.390kg	
				3	LR4-302WJNW[U]	3.0W	0.275kg	
				4	LR4-402WJNW[U]	4.0W	0.310kg/0.460kg	
				5	LR4-502WJNW[U]	5.0W	0.345kg/0.495kg	
		φ50	-	1	LR4-102WJBW[U]	2.0W	0.240kg/0.390kg	
				2	LR4-202WJBW[U]	3.0W	0.275kg/0.425kg	
				3	LR4-302WJBW[U]	4.0W	0.310kg/0.460kg	
				4	LR4-402WJBW[U]	5.0W	0.345kg/0.495kg	
				5	LR4-502WJBW[U]	6.0W	0.380kg/0.530kg	
φ60	-	1	LR5-102WJNW	1.0W	0.240kg			
		2	LR5-202WJNW	2.0W	0.280kg			
		3	LR5-302WJNW	3.0W	0.360kg			
		4	LR5-402WJNW	4.0W	0.360kg			
		5	LR5-502WJNW	5.0W	0.400kg			
φ70	-	1	LR5-102WJBW	2.0W	0.290kg			
		2	LR5-202WJBW	3.0W	0.330kg			
		3	LR5-302WJBW	4.0W	0.370kg			
		4	LR5-402WJBW	5.0W	0.410kg			
		5	LR5-502WJBW	6.0W	0.450kg			
100 - 240V AC	φ40	-	1	LR4-1M2WJNW	1.5W	0.285kg		
			2	LR4-2M2WJNW	3.0W	0.320kg		
			3	LR4-3M2WJNW	4.5W	0.355kg		
			4	LR4-4M2WJNW	6.0W	0.390kg		
			5	LR4-5M2WJNW	7.5W	0.425kg		
			φ60	-	1	LR6-1M2WJNW	1.5W	0.380kg
					2	LR6-2M2WJNW	3.0W	0.440kg
					3	LR6-3M2WJNW	4.5W	0.500kg
					4	LR6-4M2WJNW	6.0W	0.560kg
					5	LR6-5M2WJNW	7.5W	0.620kg
	φ50	O			1	LR6-1M2WJBW	3.0W	0.320kg
					2	LR6-2M2WJBW	4.5W	0.355kg
					3	LR6-3M2WJBW	6.0W	0.390kg
					4	LR6-4M2WJBW	7.5W	0.425kg
					5	LR6-5M2WJBW	9.0W	0.460kg
			φ70	O	1	LR6-1M2WJBW	3.0W	0.320kg
					2	LR6-2M2WJBW	4.5W	0.350kg
					3	LR6-3M2WJBW	6.0W	0.390kg
					4	LR6-4M2WJBW	7.5W	0.425kg
					5	LR6-5M2WJBW	9.0W	0.460kg

Signal Tower

LR Series Pre-assembled Models

Mounting Type	Rated Voltage	Size	Flash/Buzzer	Tiers	Model	Power Consumption	Mass	
Pole Mount with Circular Bracket (Also available in silver)	12V DC	φ50	-	1	LR5-101PJNW	1.0W	0.420kg	
				2	LR5-201PJNW	2.0W	0.460kg	
				3	LR5-301PJNW	3.0W	0.500kg	
				4	LR5-401PJNW	4.0W	0.540kg	
				5	LR5-501PJNW	5.0W	0.580kg	
				O	1	LR5-101PJBW	2.1W	0.470kg
					2	LR5-201PJBW	3.1W	0.510kg
					3	LR5-301PJBW	4.4W	0.550kg
					4	LR5-401PJBW	5.1W	0.590kg
					5	LR5-501PJBW	6.1W	0.630kg
	24V DC	φ40	-	1	LR4-102PJNW[U]	1.0W	0.395kg/0.545kg	
				2	LR4-202PJNW[U]	2.0W	0.430kg/0.580kg	
				3	LR4-302PJNW[U]	3.0W	0.465kg/0.615kg	
				4	LR4-402PJNW[U]	4.0W	0.500kg/0.650kg	
				5	LR4-502PJNW[U]	5.0W	0.535kg/0.685kg	
O		1		LR4-102PJBW[U]	2.0W	0.430kg/0.580kg		
		2		LR4-202PJBW[U]	3.0W	0.465kg/0.615kg		
		3		LR4-302PJBW[U]	4.0W	0.500kg/0.650kg		
		4		LR4-402PJBW[U]	5.0W	0.535kg/0.685kg		
		5		LR4-502PJBW[U]	6.0W	0.570kg/0.720kg		
φ50	-	1	LR5-102PJNW	1.0W	0.420kg			
		2	LR5-202PJNW	2.0W	0.460kg			
		3	LR5-302PJNW	3.0W	0.500kg			
		4	LR5-402PJNW	4.0W	0.540kg			
		5	LR5-502PJNW	5.0W	0.580kg			
		O	1	LR5-102PJBW	2.0W	0.470kg		
			2	LR5-202PJBW	3.0W	0.510kg		
			3	LR5-302PJBW	4.0W	0.550kg		
			4	LR5-402PJBW	5.0W	0.590kg		
			5	LR5-502PJBW	6.0W	0.630kg		
φ60	-	1	LR6-102PJNW[U]	1.0W	0.460kg/0.590kg			
		2	LR6-202PJNW[U]	2.0W	0.520kg/0.650kg			
		3	LR6-302PJNW[U]	3.0W	0.580kg/0.710kg			
		4	LR6-402PJNW[U]	4.0W	0.640kg/0.770kg			
		5	LR6-502PJNW[U]	5.0W	0.700kg/0.830kg			
		O	1	LR6-102PJBW[U]	2.0W	0.520kg/0.650kg		
			2	LR6-202PJBW[U]	3.0W	0.580kg/0.710kg		
			3	LR6-302PJBW[U]	4.0W	0.640kg/0.770kg		
			4	LR6-402PJBW[U]	5.0W	0.700kg/0.830kg		
			5	LR6-502PJBW[U]	6.0W	0.760kg/0.890kg		
100 - 240V AC	φ40	-	1	LR4-1M2PJNW	1.5W	0.475kg		
			2	LR4-2M2PJNW	3.0W	0.510kg		
			3	LR4-3M2PJNW	4.5W	0.545kg		
			4	LR4-4M2PJNW	6.0W	0.580kg		
			5	LR4-5M2PJNW	7.5W	0.615kg		
			O	1	LR4-1M2PJBW	3.0W	0.510kg	
				2	LR4-2M2PJBW	4.5W	0.545kg	
				3	LR4-3M2PJBW	6.0W	0.580kg	
				4	LR4-4M2PJBW	7.5W	0.615kg	
				5	LR4-5M2PJBW	9.0W	0.650kg	
	φ60	-	1	LR6-1M2PJNW	1.5W	0.560kg		
			2	LR6-2M2PJNW	3.0W	0.620kg		
			3	LR6-3M2PJNW	4.5W	0.680kg		
			4	LR6-4M2PJNW	6.0W	0.740kg		
			5	LR6-5M2PJNW	7.5W	0.800kg		
O	1		LR6-1M2PJBW	3.0W	0.620kg			
	2		LR6-2M2PJBW	4.5W	0.680kg			
	3		LR6-3M2PJBW	6.0W	0.740kg			
	4		LR6-4M2PJBW	7.5W	0.800kg			
	5		LR6-5M2PJBW	9.0W	0.860kg			

Standard Parts Included:
300mm Pole
POLE22-0300AN
Circular-Bracket
SZP-003[W/U]
Waterproof Ring
B25110047-F1

Mounting Type	Rated Voltage	Size	Flash/Buzzer	Tiers	Model	Power Consumption	Mass	
Pole Mount with L-bracket	12V DC	φ50	-	1	LR5-101LJNW	1.0W	0.530kg	
				2	LR5-201LJNW	2.0W	0.570kg	
				3	LR5-301LJNW	3.0W	0.610kg	
				4	LR5-401LJNW	4.0W	0.650kg	
				5	LR5-501LJNW	5.0W	0.690kg	
				O	1	LR5-101LJBW	2.1W	0.580kg
					2	LR5-201LJBW	3.1W	0.620kg
					3	LR5-301LJBW	4.1W	0.660kg
					4	LR5-401LJBW	5.1W	0.700kg
					5	LR5-501LJBW	6.1W	0.740kg
	24V DC	φ40	-	1	LR4-102LJNW[U]	1.0W	0.495kg/0.645kg	
				2	LR4-202LJNW[U]	2.0W	0.530kg/0.680kg	
				3	LR4-302LJNW[U]	3.0W	0.565kg/0.715kg	
				4	LR4-402LJNW[U]	4.0W	0.600kg/0.750kg	
				5	LR4-502LJNW[U]	5.0W	0.635kg/0.785kg	
O		1		LR4-102LJBW[U]	2.0W	0.530kg/0.680kg		
		2		LR4-202LJBW[U]	3.0W	0.565kg/0.715kg		
		3		LR4-302LJBW[U]	4.0W	0.600kg/0.750kg		
		4		LR4-402LJBW[U]	5.0W	0.635kg/0.785kg		
		5		LR4-502LJBW[U]	6.0W	0.670kg/0.820kg		
φ50	-	1	LR5-102LJNW	1.0W	0.530kg			
		2	LR5-202LJNW	2.0W	0.570kg			
		3	LR5-302LJNW	3.0W	0.610kg			
		4	LR5-402LJNW	4.0W	0.650kg			
		5	LR5-502LJNW	5.0W	0.690kg			
		O	1	LR5-102LJBW	2.0W	0.580kg		
			2	LR5-202LJBW	3.0W	0.620kg		
			3	LR5-302LJBW	4.0W	0.660kg		
			4	LR5-402LJBW	5.0W	0.700kg		
			5	LR5-502LJBW	6.0W	0.740kg		
φ60	-	1	LR6-102LJNW[U]	1.0W	0.560kg/0.700kg			
		2	LR6-202LJNW[U]	2.0W	0.620kg/0.760kg			
		3	LR6-302LJNW[U]	3.0W	0.680kg/0.820kg			
		4	LR6-402LJNW[U]	4.0W	0.740kg/0.880kg			
		5	LR6-502LJNW[U]	5.0W	0.800kg/0.940kg			
		O	1	LR6-102LJBW[U]	2.0W	0.620kg/0.760kg		
			2	LR6-202LJBW[U]	3.0W	0.680kg/0.820kg		
			3	LR6-302LJBW[U]	4.0W	0.740kg/0.880kg		
			4	LR6-402LJBW[U]	5.0W	0.800kg/0.940kg		
			5	LR6-502LJBW[U]	6.0W	0.860kg/1.000kg		
100-240V AC*	φ40	-	1	LR4-1M2LJNW	1.5W	0.575kg		
			2	LR4-2M2LJNW	3.0W	0.610kg		
			3	LR4-3M2LJNW	4.5W	0.645kg		
			4	LR4-4M2LJNW	6.0W	0.680kg		
			5	LR4-5M2LJNW	7.5W	0.715kg		
			O	1	LR4-1M2LJBW	3.0W	0.610kg	
				2	LR4-2M2LJBW	4.5W	0.645kg	
				3	LR4-3M2LJBW	6.0W	0.680kg	
				4	LR4-4M2LJBW	7.5W	0.715kg	
				5	LR4-5M2LJBW	9.0W	0.750kg	
	φ60	-	1	LR6-1M2LJNW	1.5W	0.660kg		
			2	LR6-2M2LJNW	3.0W	0.720kg		
			3	LR6-3M2LJNW	4.5W	0.780kg		
			4	LR6-4M2LJNW	6.0W	0.840kg		
			5	LR6-5M2LJNW	7.5W	0.900kg		
O	1		LR6-1M2LJBW	3.0W	0.720kg			
	2		LR6-2M2LJBW	4.5W	0.780kg			
	3		LR6-3M2LJBW	6.0W	0.840kg			
	4		LR6-4M2LJBW	7.5W	0.900kg			
	5		LR6-5M2LJBW	9.0W	0.960kg			
24V DC	φ60	-	3	LR6-302WCNW	3.0W	0.350kg		

Standard Parts Included:
300mm Pole
POLE22-0300AT
L-Bracket
SZL-001
Waterproof Ring
B25110047-F1

Direct Mount With M12 Connector
*Cable not included

* Not suitable for KC (KN 61000-6-4, KN 61000-6-2) and Low Voltage Directive (TEC / EN 60947-5-1, EN 62471).

LR Series Modular Models

Select a Buzzer Unit (for Flashing / Buzzer function)



Size	Color	Model
φ40		LR4-B□
φ50		LR5-B□
φ60		LR6-B□
φ70		LR7-B□

□•••W: Off-white U: Silver K: Black

Select an LED Unit



Size	Color	Model
φ40		LR4-E-R/Y/G/B/C
		LR4-E-RZ/YZ/GZ/BZ CLEAR
φ50		LR5-E-R/Y/G/B/C
		LR4-E-RZ/YZ/GZ/BZ CLEAR
φ60		LR6-E-R/Y/G/B/C
		LR6-E-RZ/YZ/GZ/BZ CLEAR
φ70		LR7-E-R/Y/G/B/C
φ60		LR6-E-MZ Multi-color

Select a Body Unit

Mounting Type	Rated Voltage	Size	Model
 Pole Mount with Circular Bracket/Cable	12V DC	φ50	LR5-01PJNW
		φ40	LR4-02PJNW[U]
	24V DC	φ50	LR5-02PJNW
		φ60	LR6-02PJNW[U]
	100 - 240V AC	φ40	LR4-M2PJNW
		φ60	LR6-M2PJNW
 Pole Mount with L-bracket/Cable	12V DC	φ50	LR5-01LJNW
		φ40	LR4-02LJNW[U]
	24V DC	φ50	LR5-02LJNW
		φ60	LR6-02LJNW[U]
	100 - 240V AC	φ40	LR4-M2LJNW
		φ60	LR6-M2LJNW
 Pole Mount with Folding Bracket/Cable	24V DC	φ40	LR4-02QJNW
		φ60	LR6-02QJNW

W = Off-white, U = Silver, K = Black

Body Unit Model Code

(Ex.) **LR6-02WJNW**

Model ① ② ③ ④ ⑤

- ① Size
4 = φ40
5 = φ50
6 = φ60
7 = φ70
 - ② Rated Voltage
01 = 12V DC*¹
02 = 24V DC
M2 = 100 - 240V AC*²
 - ③ Mounting/Wiring
WJ = Direct Mount/Cable
WT = Direct Mount/Terminal*³
KT = Knock-outs Mount/Terminal*³
WC = Direct Mount/M12 Connector*⁴
LJ = Pole Mount with L-bracket/Cable*⁵
PJ = Pole Mount with Circular Bracket/Cable*⁵
QJ = Pole Mount with Folding Bracket/Cable*⁶
 - ④ Flashing/Buzzer
N = No Flashing/Buzzer
 - ⑤ Body Color
W = Off-white
U = Silver*⁷
K = Black*⁸
- ¹ For LR5 models only
² For WJ, LJ and PJ mounting with LR4 and LR6 models
³ For LR5, LR7 DC24V models only
⁴ For LR6 DC24V models only
⁵ For LR4, LR5 and LR6 models
⁶ For LR4 and LR6 DC24V Off-white models only
⁷ For LR4 and LR6 only
⁸ For LR5, LR7 models only

3 Easy Steps

1 Remove the headcover to setup the body unit



2 Attach from bottom to top, one LED unit at a time to the body unit



3 Replace the headcover, or attach the buzzer unit



See the Movie!!

Scan the QR code to see how easy the LR is to configure.



Mounting Type	Rated Voltage	Size	Model
 Direct Mount/Cable	12V DC	φ50	LR5-01WJNW
		φ40	LR4-02WJNW[U]
	24V DC	φ50	LR5-02WJNW
		φ60	LR6-02WJNW[U]
	100 - 240V AC	φ40	LR4-M2WJNW
		φ60	LR6-M2WJNW
 Direct Mount/Screwless Terminal	24V DC	φ50	LR5-02WTNW[U][K]
		φ70	LR7-02WTNW[U][K]
 Knock-out Mount/Screwless Terminal	24V DC	φ50	LR5-02KTNW[U][K]
		φ70	LR7-02KTNW[U][K]
 Direct Mount/M12 Connector	24V DC	φ60	LR6-02WCNW

W = Off-white, U = Silver, K = Black

Removable Screwless Terminal



The terminal can be pulled out



LR Series Optional Parts

Direct Mount Brackets

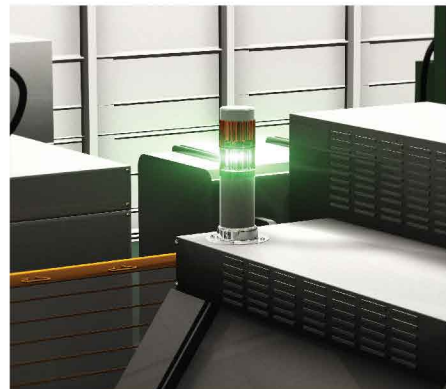

Circular Bracket

Model: SZW-001W
Material: SPCE

■ Mounting Dimensions (Unit: mm)

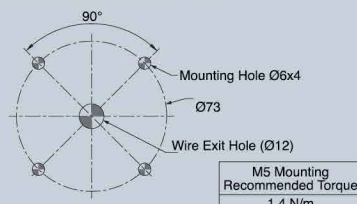

Wall-mount Bracket

Model: SZK-002W/U/K
Material: PC

SZK-003W/U/K
Material: PC

SZK-004W
Material: PC

■ Mounting Dimensions (Unit: mm)

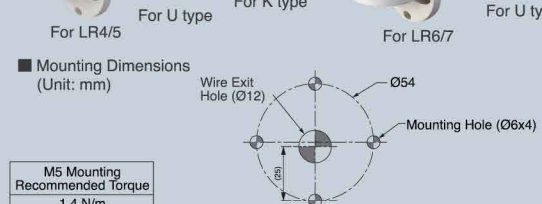

The wiring can exit through the bracket.
*An M16xP1.5 cable gland attachment needs to be purchased additionally

N Type Aluminum Pole Brackets

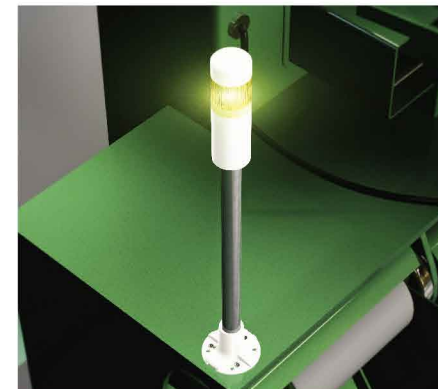

Circular Multiple-mount Bracket

Model: SZP-001W
Accessories: Waterproof Packing Pole Waterproof Ring Binding Head Tapping Screw - (2 pcs.)

Material: PC

■ Mounting Dimensions (Unit: mm)

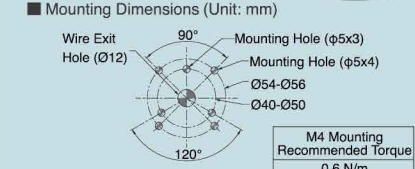

Circular Bracket

Model: SZP-002U

Accessories: Pole Waterproof Ring Binding Head Tapping Screw (2 pcs.)

Material: ADC12

■ Mounting Dimensions (Unit: mm)

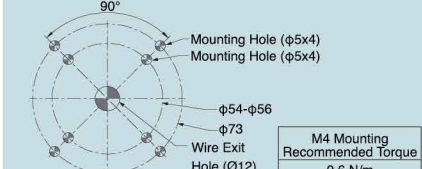

Circular Bracket

Model: SZP-003W/U/K

Accessories: Waterproof Packing Pole Waterproof Ring Binding Head Tapping Screw (2 pcs.)

Material: PC

■ Mounting Dimensions (Unit: mm)

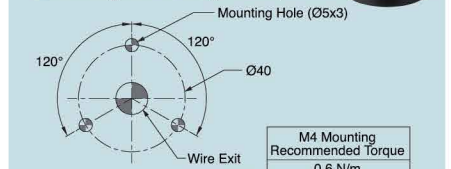

N Type Aluminum Folding Brackets



1 Depressing a locking lever on the left side of the folding bracket releases it to be lowered.



2 Press the folding bracket forward and push about 15° in the clockwise direction.



3 The folding bracket is pushed down to the right (clockwise) until it locks in place with a "Click!" sound.



Folding Bracket

Model: SZQ-001W
Accessories: Pole Waterproof Ring Binding Head Tapping Screw - (2 pcs.)

Material: PC

■ Mounting Dimensions (Unit: mm)

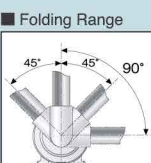
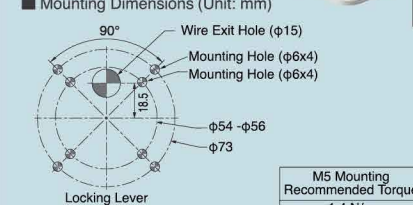

T Type Aluminum Pole Brackets

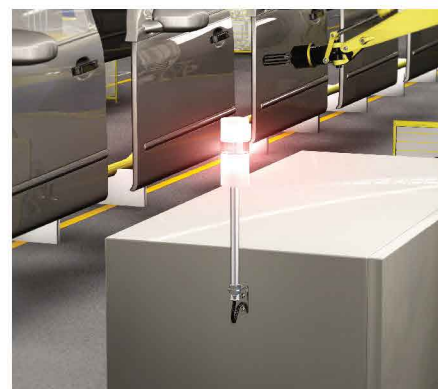

L-bracket

Model: SZL-001
Material: SPHC-P

■ Mounting Dimensions (Unit: mm)

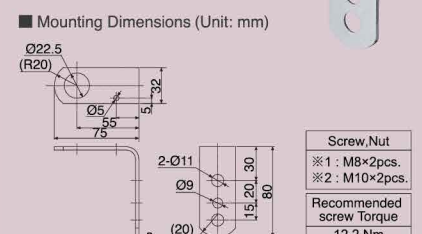

N & T Aluminum Pole Brackets



Wall-mount Bracket

Model: SZK-001U
Accessories: Hexagon Socket Set Screw (2 pcs.)

Material: ADC12

■ Mounting Dimensions (Unit: mm)

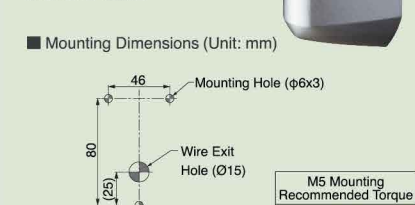

1/2" NPT Pipes Pole Brackets

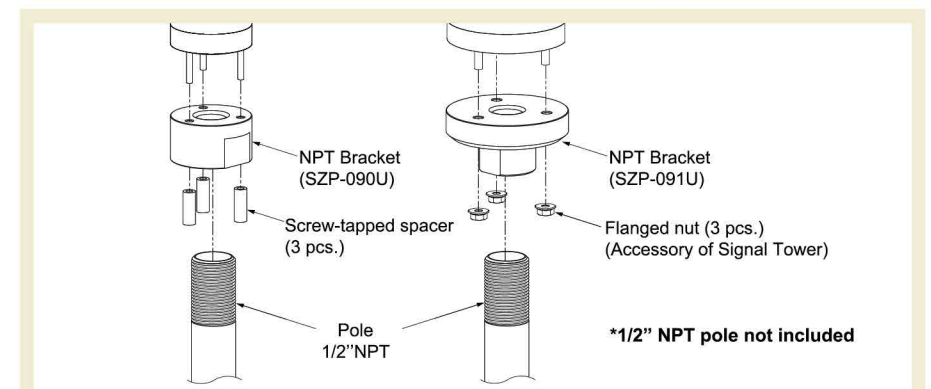

1/2" NPT Bracket

Model: SZP-090U
Accessories: Screw-tapped spacer (3 pcs.)

Material: AL

■ Mounting Dimensions (Unit: mm)

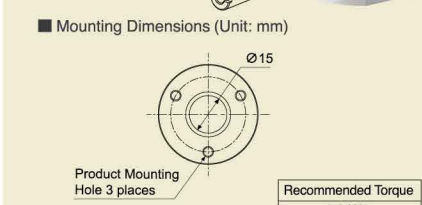

Model: SZP-091U
Material: AL

■ Mounting Dimensions (Unit: mm)

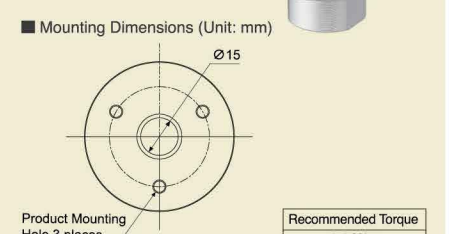

Signal Tower

LR Series Optional Parts

N & T Aluminum Pole Brackets

Wall-mount Bracket

Model: **SZ-020** For $\phi 21.7$ mm Pole
 Accessories: Set Screw
 Material: ABS



Wire connector
 SZ-020-001
 (Sold Separately)

■ Mounting Dimensions (Unit: mm)

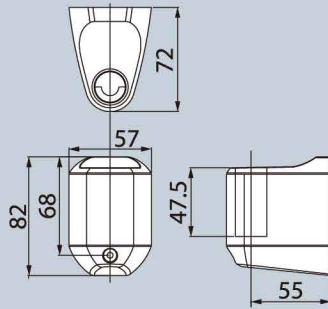
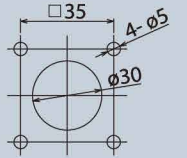

* SZ-020 is a detachable quick disconnect

Circular Bracket

Model: **SZ-010** For $\phi 21.7$ mm Pole
 Accessories: Hexagon socket set screws (2 pcs.)
 Material: ADC12

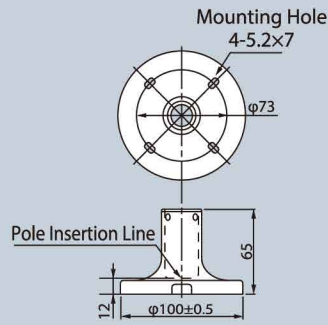

Circular Bracket

Model: **SZ-016A** For $\phi 21.7$ mm Pole
 Accessories: Rubber bushing, Water proof sheet, Hexagon socket set screws (2 pcs.)
 Material: ADC12

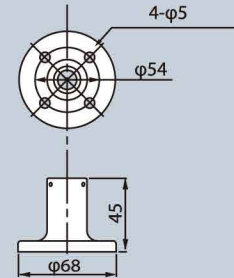

NPT Bracket

Model: **SZ-904**
 Material: AL



■ Mounting Dimensions (Unit: mm)

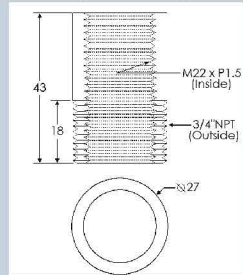

Replacement Parts

■ O-ring (5 per pack)/Headcover

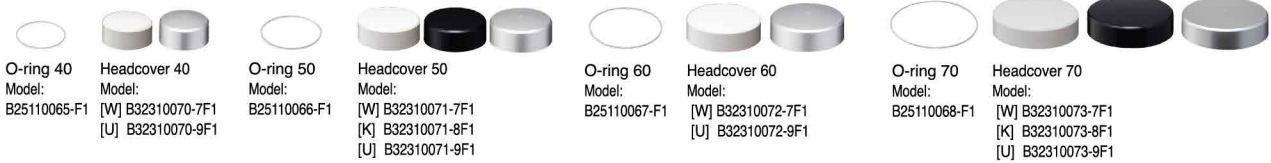

■ Base Unit

• Adaptor for Aluminum Pole
 O-ring, Binding Head Tapping Screw for pole fixing and Pole Waterproof Ring are included.

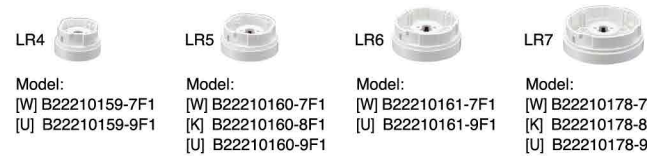

■ Terminal Block (LR5 & LR7 only)



■ Filter Sheet (5 per pack)



■ Pole Waterproof Ring



Signal Tower

Optional Parts and Poles

Optional Mounting Brackets (For Poles)

Model	Model Name	IP	LR4	LR5	LR6	LR7
	SZP-001W	65	PJ, QJ	PJ, KT *1	PJ, QJ	KT *1
	SZP-002U	20	PJ, QJ	PJ, KT *1	PJ, QJ	KT *1
	SZP-003W[U][K]	65	PJ, QJ	PJ, KT *1	PJ, QJ	KT *1
	SZL-001	54	LJ	LJ, KT *1	LJ	LJ, KT *1
	SZQ-001W	65	PJ, QJ	PJ, KT *1	PJ, QJ	KT *1
	SZK-001U	20	PJ, QJ	PJ, KT *1	PJ, QJ	KT *1
	SZ-020	54	PJ, QJ	PJ, KT *1	PJ, QJ	KT *1
	SZ-016A	20	PJ, QJ	PJ, KT *1	PJ, QJ	KT *1
	SZ-010	20	PJ, QJ	PJ, KT *1	PJ, QJ	KT *1
	SZ-904	20	LJ	LJ, KT *1	LJ	LJ, KT *1

Optional Mounting Brackets (Without Poles)

	SZP-090U	-	WJ	WJ, WT, KT *2	-	-
	SZP-091U	-	-	-	WJ	WJ, WT, KT *2
	SZK-002W[U][K]	65	WJ	WJ, WT, KT *2	-	-
	SZK-003W[U][K]	65	-	-	WJ	WJ, WT, KT *2
	SZK-004W	65	-	-	WJ	WJ, WT, KT *2
	SZW-001W	-	WJ	WJ, WT, KT *2	WJ	-

*1 Required pole and pole waterproof ring are not included with KT. *2 KT Direct Mount (Using accessory)

Optional Aluminum Poles

Model Type	Model Name	SZP-001W IP65	SZP-002U IP20	SZP-003W IP65	SZQ-001W IP65	SZK-001U IP20	SZL-001 IP54	SZ-020 IP54	SZ-010 IP20	SZ-016A IP20	SZ-904 -
N Type	POLE22-0100AN[K] 100mm	○	○	○	○	○	×	○	○	○	×
	POLE22-0300AN[K] 300mm	○	○	○	○	○	×	○	○	○	×
	POLE22-0500AN 500mm	×	○	×	×	○	×	○	○	○	×
NK Type	POLE22-0800AN[K] 800mm	×	○	×	×	○	×	○	○	○	×
	POLE22-1000AN 1000mm	×	○	×	×	○	×	○	○	○	×
	POLE22-0100AT 100mm	×	×	×	×	○	○	○	○	×	○
T Type	POLE22-0300AT 300mm	×	×	×	×	○	○	○	○	×	○
	POLE22-0500AT 500mm	×	×	×	×	○	○	○	○	×	○
	POLE22-0800AT 800mm	×	×	×	×	○	○	○	○	×	○
	POLE22-1000AT 1000mm	×	×	×	×	○	○	○	○	×	○

Note: Two self-tapping pole mounting screws included. To convert from direct mount to pole mount, be sure to purchase the appropriate bracket and pole combination.

Wiring Diagrams

■ Wire Type & Wire Gauge
 Wire TypeUL2464
 Wire Gauge...[01] 12V DC [02] 24V DC
 Signal Wire : AWG24
 Power Supply Wire : AWG24

Product Specifications **01** 12V DC **02** 24V DC

External Contact Classification

Voltage Contact Relay

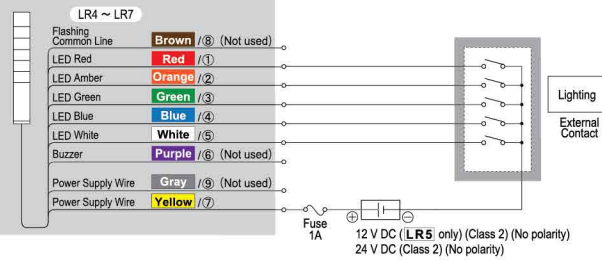

External Contact Classification

PLC (NPN Transistor)

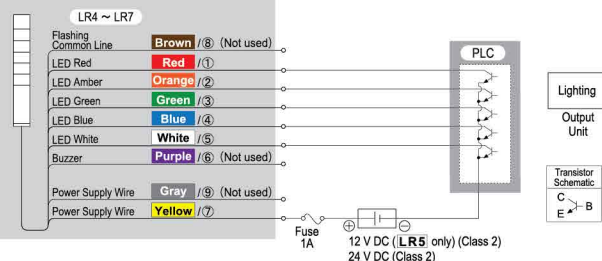

External Contact Classification

PLC (PNP Transistor)

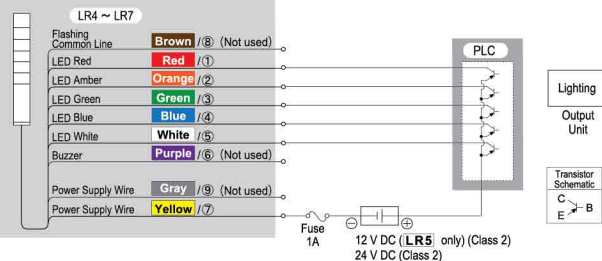

LED Red **RED** / ①
 Function Name
 Lead Wire Color (Cable type)
 Pos No. **WT** Direct Mount with Terminal Block, **KT** Mounting Bracket with knock-outs Terminal Block
(Note) The last wire color does not indicate the LED fluorescence color. Refer to pg. 16 "Terminal Block Array"

Product Specifications **01** 12V DC **02** 24V DC

External Contact Classification

Voltage Contact Relay

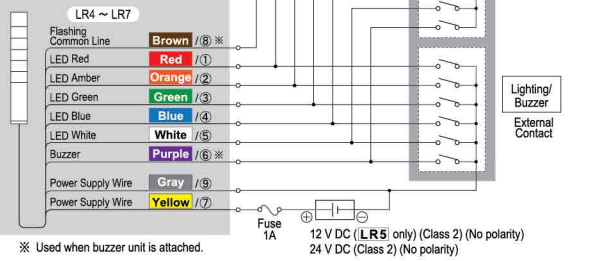

External Contact Classification

PLC (NPN Transistor)

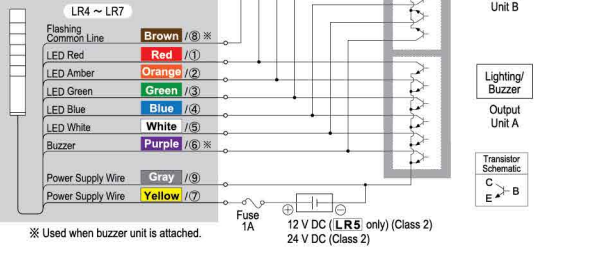

External Contact Classification

PLC (PNP Transistor)

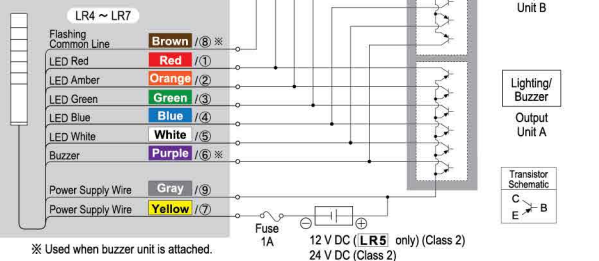

《LR Series 2-Buzzer Operation Method》
 Connecting the Buzzer wire (Purple) with the Flashing Common wire (Brown) will control the selection of two different buzzer sounds.

Multi-color Wiring Diagrams

Multi-color LED Unit wire colors are **RED** / ①; **Green** / ③; **Blue** / ④. Wire colors **Orange** / ② and **White** / ⑤ are not used.
 Refer to the Complete User's Manual for details.

LR6-E-MZ Lighting

LED Color	Wire Color
Red	Red
Green	Green
Blue	Blue
Amber	Red + Green
Purple	Red + Blue
Cyan	Green + Blue
White	Red + Green + Blue

Lighting / Flashing / Buzzer (LR6-E-MZ)

Product Specifications **02** 24V DC

External Contact Classification

Voltage Contact Relay

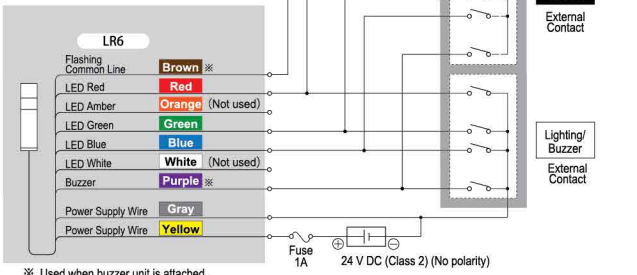

External Contact Classification

PLC (NPN Transistor)

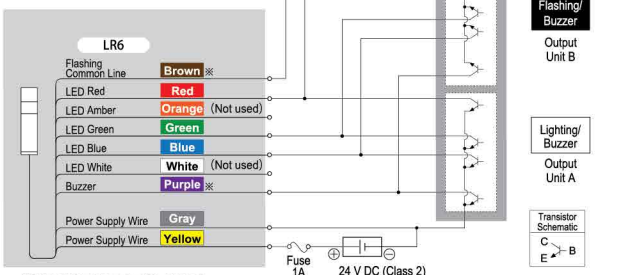

External Contact Classification

PLC (PNP Transistor)

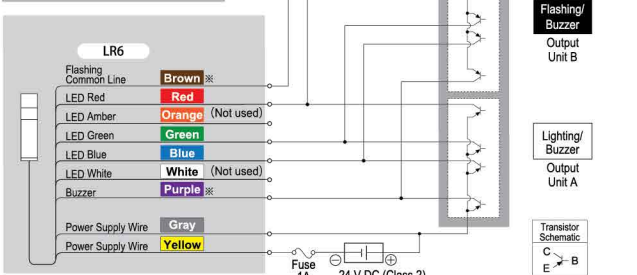

Point
 • When flashing the LR6-E-MZ simultaneously with the LR6-E-R(Z)/Y(Z)/G(Z)/B(Z)/C, the flashing cycle of the LR6-E-MZ may shift from the other LED units.

M12 (LR6-WC) Wiring Diagrams

LED Red **RED** / ⑥
 Function Name
 PIN No. **WC** Direct Mount with M12 Connector

Lighting / Buzzer (LR6-WC)

Product Specifications **02** WC 24V DC

External Contact Classification

Voltage Contact Relay

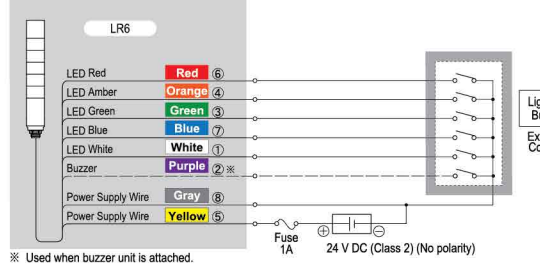

External Contact Classification

PLC (NPN Transistor)

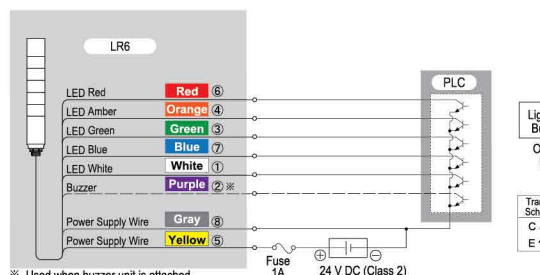

External Contact Classification

PLC (PNP Transistor)

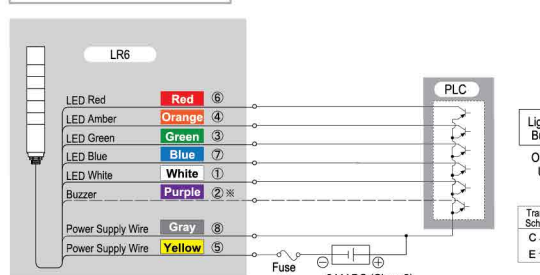

Point
 • The flashing function cannot be used.

Product Specifications **M2** 100 - 240 V AC

External Contact Classification

Voltage Contact Relay

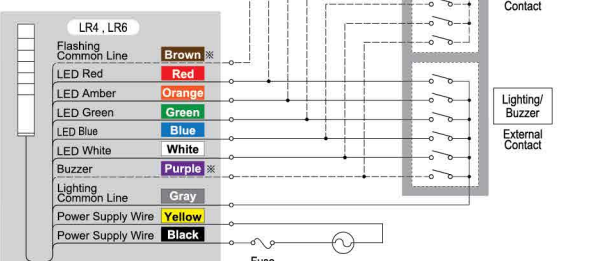

■ Wire Type & Wire Gauge
 Wire TypeUL2464
 Wire Gauge...[M2] 100~240V AC
 Signal Wire : AWG24
 Power Supply Wire : AWG18

External Contact Classification

PLC (NPN Transistor)

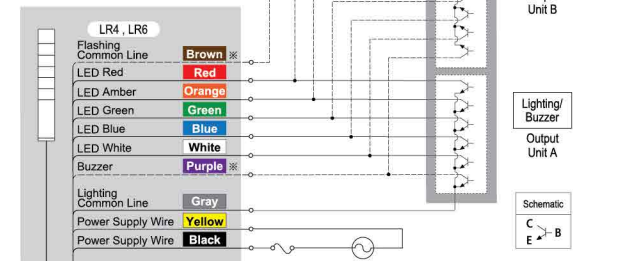

[WT],[KT] Terminal Type

Wiring Method

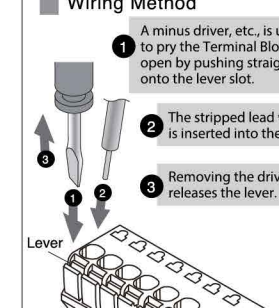

Terminal Block Array

9	Black	Power (Signal)
8	Gray	Flashing Common
7	Yellow	Power (Common)
6	Gray	Buzzer
5	White	LED White
4	Blue	LED Blue
3	Green	LED Green
2	Orange	LED Yellow
1	Red	LED Red

Recommended lead wire specification
 Wire Type Wire (Solid) Wire (Frayed)
 UL1007 / UL1430 0.14 - 1.5mm AWG30 - 14
 • Temperature rating should be above 75°C, and the conductor material should be of copper wire.

M12 Connector Pin Layout

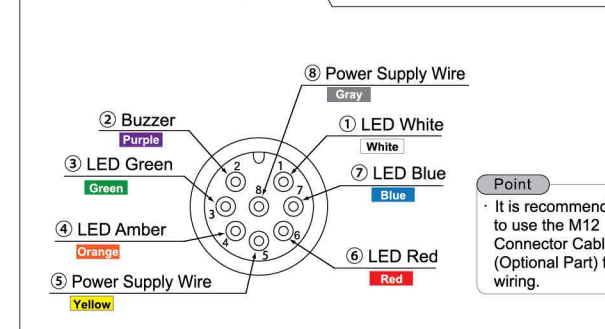

Outer Dimensional Drawing (Unit: mm)

Mount A [WJ] Direct Mount/Cable
(01: 12V DC / 02: 24V DC) (M2: 100-240V AC)

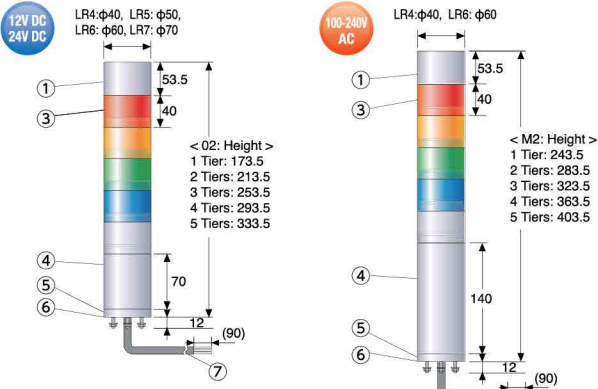

Maximum Panel Thickness: 7
Cable Length: (1300)
U type: (3300)
Cable Diameter: φ7.5

No.	Description	Material
1	Buzzer Unit	PC
2	Head Cover	PC
3	LED Unit	Globe: PC
4	Body	PC
5	Direct Mount Bracket	PC
6	Waterproof Packing	Silicon Rubber
7	Cable	PVC

Mount B [LJ] Pole Mount with L-bracket & Cable
(01: 12V DC / 02: 24V DC) (M2: 100-240V AC)

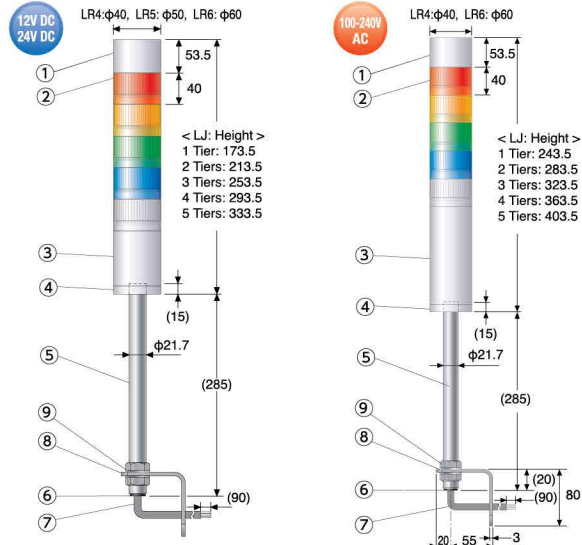

Cable Length: (1000)
U type: (3000)
Cable Diameter: φ7.5

No.	Description	Material
1	Buzzer Unit	PC
2	LED Unit	Globe: PC
3	Body	PC
4	Pole Bracket	PC
5	Pole	AL
6	Rubber Bushing	EPR Rubber
7	Cable	PVC
8	L-bracket	Steel
9	Hexagon Nut M22	SUM

Mount A [WT] Direct Mount/ Screwless Terminal (Body Unit)

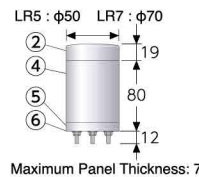

Mount A [PJ] Pole Mount with/Circular Bracket & Cable
(01: 12V DC / 02: 24V DC) (M2: 100-240V AC)

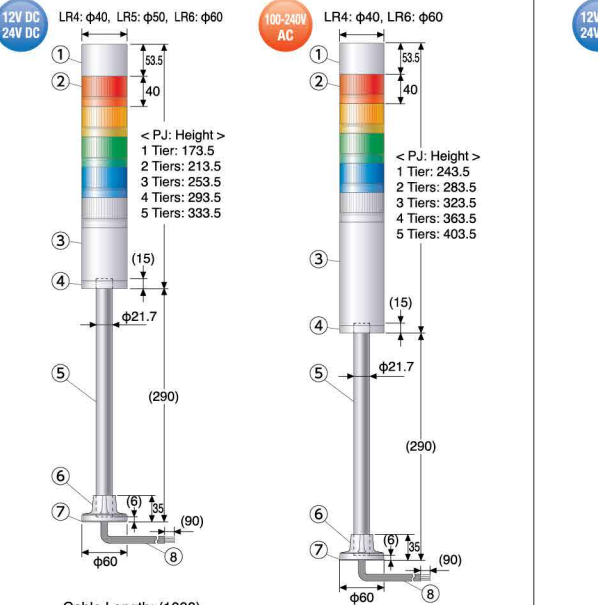

Cable Length: (1000)
U type: (3000)
Cable Diameter: φ7.5

No.	Description	Material
1	Buzzer Unit	PC
2	LED Unit	Globe: PC
3	Body	PC
4	Pole Bracket	PC
5	Pole	AL
6	Circular Bracket	PC
7	Waterproof Packing	Silicon Rubber
8	Cable	PVC

Mount C [QJ] Pole Mount with/Folding Bracket & Cable
(02: 24V DC)

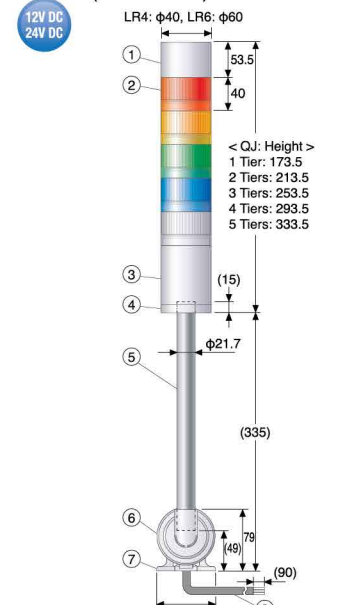

Cable Length: (950)
Cable Diameter: φ7.5

No.	Description	Material
1	Buzzer Unit	PC
2	LED Unit	Globe: PC
3	Body	PC
4	Pole Bracket	PC
5	Pole	AL
6	Folding Bracket	PC
7	Waterproof Packing	CR
8	Cable	PVC

[WC] Direct Mount with M12 Connector
(02: 24V DC)

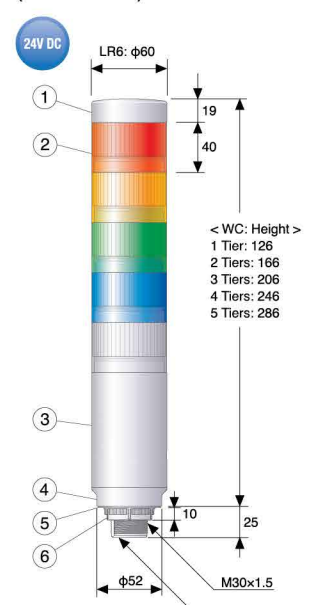

Maximum Panel Thickness: 10

No.	Description	Material
1	Head Cover	PC
2	LED Unit	Globe: PC
3	Body	PC
4	Direct Mount Bracket	PC
5	Waterproof Packing (t=1)	Silicone Rubber
6	M30 Nut	PC

Mounting Dimensions (Unit: mm)

Mount A Mounting Diagram [WJ] / [PJ] / [WT] / [KT]

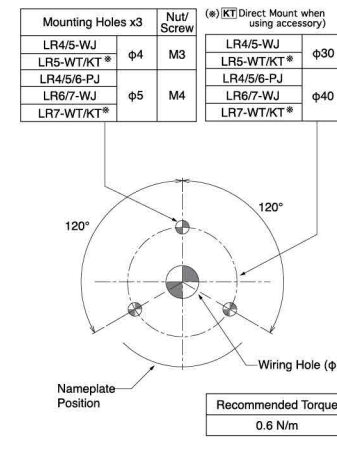

Mount B Mounting Diagram [LJ]

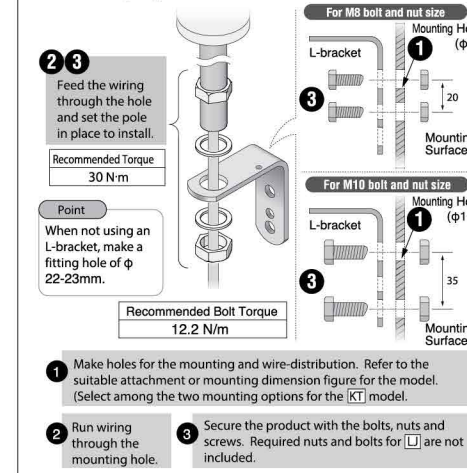

Mount C Mounting Diagram [QJ]

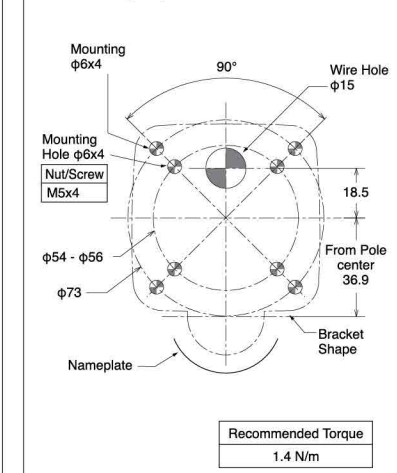

Specifications

Operating Ambient Temperature	-20 - +50°C
Operating Ambient Humidity	Less than 90% RH (No Condensation)
Storage Ambient Temperature	-30 - +60°C
Storage Ambient Humidity	Less than 90% RH (No Condensation)
Mounting Location	Indoor Only
Mounting Direction	Upright
Protection Rating ^{*1}	IP65 (IEC 60529) / NEMA TYPE 4X, 13
Environmental Conditions	Upright
Insulation Resistance	More than 1MΩ at DC500V between live part and non-current carrying metallic part
Withstand Voltage	500V AC applied for 1 minute between live part and non-current carrying metallic part without breaking insulation (M2: 1500V AC for 1 min.)
Flash Rate	60 ±2 Flashes Per Minute
Sound Pressure Level	LR4 Typ. 85dB LR5 Typ. 85dB LR6 Typ. 88dB LR7 Typ. 90dB LR5 DC12V Typ. 80dB
Sound Reduction ^{*2}	Approx. -10dB
Environmental Conditions	Buzzer Sound No.4 was measured from the total circumference of the Buzzer Unit at 1m
Buzzer Sound	4 patterns ^{*2} No.1 Rapid Intermittent beep No.2 Continuous beep sound No.3 Rapid Hi-low No.4 Sweep sound
Transistor Output	NPN / PNP (100 - 240V AC is NPN only)
Conformity Standards	<ul style="list-style-type: none"> <input type="checkbox"/>UL 508, CSA-C22.2 No.14 <input type="checkbox"/>FCC Part 15 Subpart B Class A <input type="checkbox"/>RoHS Directive (EN 50581) <input type="checkbox"/>EMC Directive (EN 61000-6-4, EN 61000-6-2) <input type="checkbox"/>KC (KN 61000-6-4, KN 61000-6-2)^{*3} <input type="checkbox"/>Low-voltage Directive (IEC/EN 60947-5-1, EN62471)^{*4}

*1: LJ Type is IP54 *2: Dependent on DIP Switch Settings *3: Except KT and M2 LJ Type *4: M2 Type Only (Except LJ Type)

External Contact Capacity

Rated Load Voltage	Is:Current Capacity Vs:Withstand Voltage I _L :Leakage Current Ta:Ambient Temperature			
	01 12V DC	02 24V DC	M2 100 - 240V AC	
LED Unit (1 Tier)	Signal Wire Current (Max.) / Voltage	100mA / Power Supply Voltage	45mA / Power Supply Voltage	45mA / 24V DC
	Recommended Contact Capacity	I _s ≥ 100mA Vs ≥ 20V DC ^{*1}	I _s ≥ 100mA Vs ≥ 35V DC	I _s ≥ 100mA Vs ≥ 35V DC
Buzzer	Signal Wire Current (Max.) / Voltage	250mA / Power Supply Voltage	250mA / Power Supply Voltage	250mA / 24V DC
	Recommended Contact Capacity	I _s ≥ 300mA Vs ≥ 20V DC ^{*1}	I _s ≥ 300mA Vs ≥ 35V DC	I _s ≥ 300mA Vs ≥ 35V DC
Power Supply	Current Consumption (Max.)	500mA	250mA	150mA
	Recommended Contact Capacity	I _s ≥ 700mA Vs ≥ 20VDC	I _s ≥ 500mA Vs ≥ 35V DC	Inrush current or more contacts
Inrush Current	Signal Wire	LED None ^{*1} / Buzzer None	LED None / Buzzer None	None
	Power Supply Wire	0.7A / Less than 15ms	None	Ta=25°C : 25A / Less than 2ms (Cold-start) Ta=50°C : 50A / Less than 2ms (Cold-start)
Leakage Current		I _L ≤ 0.1 mA		

*1: When the (Gray) for [WJ] [LJ] [PJ] [QJ], Black / (White) for [WT] [KT], (Black) for [WC] power supply wire is not connected, inrush current of 0.7A will flow through the signal wire.
Recommended Contact Capacity : ≥ 700mA Vs ≥ 20VDC

LED Unit Specifications

Color	Red	Amber	Green	Blue	White	Multi-color
Rated Voltage	24V DC					
Current Consumption	Typ.	0.04A				
	Max.	0.045A				
Power Consumption	Typ.	1W				
	Max.	1.3W				
Conformity Standards	<ul style="list-style-type: none"> <input type="checkbox"/>UL 508, CSA-C22.2 No.14 <input type="checkbox"/>RoHS Directive (EN 50581) <input type="checkbox"/>EMC Directive (EN 61000-6-4, EN 61000-6-2) 					

Buzzer Unit Specifications

Rated Voltage	24V DC	
Current Consumption	Typ.	0.04A
	Max.	0.3A
Power Consumption	Typ.	1W
	Max.	1.3W
Conformity Standards	<ul style="list-style-type: none"> <input type="checkbox"/>UL 508, CSA-C22.2 No.14 <input type="checkbox"/>RoHS Directive (EN 50581) <input type="checkbox"/>EMC Directive (EN 61000-6-4, EN 61000-6-2) <input type="checkbox"/>FCC Part 15 Subpart B Class A 	

LR Series Compatibility Chart (φ40 - φ50)

Current Models					Succeeding Models			
Series	Voltage	Installation Type	Buzzer	Model	Model	Comment	Installation Pitch	Fixed Wiring Hole
LCE-(A) φ40	24V AC/DC	Direct Mount	○	LCE-102(A)FBW	LR4-102WJBW		○	×
				LCE-202(A)FBW	LR4-202WJBW		○	×
				LCE-302(A)FBW	LR4-302WJBW		○	×
				LCE-402(A)FBW	LR4-402WJBW		○	×
				LCE-502(A)FBW	LR4-502WJBW		○	×
				LCE-102(A)W	LR4-102WJNW		○	×
		LCE-202(A)W	LR4-202WJNW		○	×		
		LCE-302(A)W	LR4-302WJNW		○	×		
		LCE-402(A)W	LR4-402WJNW		○	×		
		LCE-502(A)W	LR4-502WJNW		○	×		
		Pole Mount (L-bracket)	○	LCE-102(A)FB	LR4-102LJBW		○	○
				LCE-202(A)FB	LR4-202LJBW		○	○
	LCE-302(A)FB			LR4-302LJBW		○	○	
	LCE-402(A)FB			LR4-402LJBW		○	○	
	LCE-502(A)FB			LR4-502LJBW		○	○	
	LCE-102(A)			LR4-102LJNW		○	○	
	Pole Mount (Wall-mount Bracket)	○	LCE-202(A)	LR4-202LJNW		○	○	
			LCE-302(A)	LR4-302LJNW		○	○	
			LCE-402(A)	LR4-402LJNW		○	○	
			LCE-502(A)	LR4-502LJNW		○	○	
			LCE-102(A)FBK	LR4-102PJBW	Purchase SZK-001U option bracket additionally.	×	×	
			LCE-202(A)FBK	LR4-202PJBW		×	×	
	LCE-302(A)FBK	LR4-302PJBW	×	×				
	LCE-402(A)FBK	LR4-402PJBW	×	×				
LCE-502(A)FBK	LR4-502PJBW	×	×					
LCE-1M2(A)FBW	LR4-1M2WJBW		○	×				
90 - 250V AC	Direct Mount	○	LCE-2M2(A)FBW	LR4-2M2WJBW		○	×	
			LCE-3M2(A)FBW	LR4-3M2WJBW		○	×	
			LCE-4M2(A)FBW	LR4-4M2WJBW		○	×	
			LCE-5M2(A)FBW	LR4-5M2WJBW		○	×	
			LCE-1M2(A)W	LR4-1M2WJNW		○	×	
			LCE-2M2(A)W	LR4-2M2WJNW		○	×	
	Pole Mount (L-bracket)	○	LCE-3M2(A)W	LR4-3M2WJNW		○	×	
			LCE-4M2(A)W	LR4-4M2WJNW		○	×	
			LCE-5M2(A)W	LR4-5M2WJNW		○	×	
			LCE-1M2(A)FB	LR4-1M2LJBW		○	○	
			LCE-2M2(A)FB	LR4-2M2LJBW		○	○	
			LCE-3M2(A)FB	LR4-3M2LJBW		○	○	
Pole Mount (L-bracket)	×	LCE-4M2(A)FB	LR4-4M2LJBW		○	○		
		LCE-5M2(A)FB	LR4-5M2LJBW		○	○		
		LCE-1M2(A)	LR4-1M2LJNW	Does not comply with Low-voltage Directive (IEC/EN 60947-5-1, EN62471).	○	○		
		LCE-2M2(A)	LR4-2M2LJNW		○	○		
		LCE-3M2(A)	LR4-3M2LJNW		○	○		
		LCE-4M2(A)	LR4-4M2LJNW		○	○		
LCE-5M2(A)	LR4-5M2LJNW	○	○					
LCS-102(A)	LR4-102LJNW	○	○					
LCS-(A) φ40	24V AC/DC	Pole Mount (L-bracket)	×	LCS-202(A)	LR4-202LJNW		○	○
				LCS-302(A)	LR4-302LJNW		○	○
				LCS-402(A)	LR4-402LJNW		○	○
		Wall-mount Bracket	×	LCS-502(A)	LR4-502LJNW		○	○
				LCS-102(A)K	LR4-102PJNW	Purchase SZK-001U option bracket additionally.	×	×
				LCS-202(A)K	LR4-202PJNW		×	×
LCS-302(A)K	LR4-302PJNW	×	×					
LE φ50	12V AC/DC	Direct Mount	○	LE-101FBW	LR5-101WJBW		○	×
				LE-201FBW	LR5-201WJBW		○	×
				LE-301FBW	LR5-301WJBW		○	×
				LE-401FBW	LR5-401WJBW		○	×
				LE-501FBW	LR5-501WJBW		○	×
				LE-101W	LR5-101WJNW		○	×
				LE-201W	LR5-201WJNW		○	×
				LE-301W	LR5-301WJNW		○	×
				LE-401W	LR5-401WJNW		○	×
		Pole Mount (L-bracket)	○	LE-501W	LR5-501WJNW		○	×
				LE-101FBP	LR5-101LJBW		○	○
				LE-201FBP	LR5-201LJBW		○	○
				LE-301FBP	LR5-301LJBW		○	○
				LE-401FBP	LR5-401LJBW		○	○
				LE-501FBP	LR5-501LJBW		○	○
				LE-101P	LR5-101LJNW		○	○
				LE-201P	LR5-201LJNW		○	○
				LE-301P	LR5-301LJNW		○	○
Pole Mount (L-bracket)	×	LE-401P	LR5-401LJNW		○	○		
		LE-501P	LR5-501LJNW		○	○		

LR Series Compatibility Chart (φ50 - φ60)

Current Models					Succeeding Models			
Series	Voltage	Installation Type	Buzzer	Model	Model	Comment	Installation Pitch	Fixed Wiring Hole
LE φ50	24V AC/DC	Direct Mount	○	LE-102FBW	LR5-102WJBW		○	×
				LE-202FBW	LR5-202WJBW		○	×
				LE-302FBW	LR5-302WJBW		○	×
				LE-402FBW	LR5-402WJBW		○	×
				LE-502FBW	LR5-502WJBW		○	×
				LE-102W	LR5-102WJNW		○	×
		Pole Mount (L-bracket)	○	LE-202W	LR5-202WJNW		○	×
				LE-302W	LR5-302WJNW		○	×
				LE-402W	LR5-402WJNW		○	×
				LE-502W	LR5-502WJNW		○	×
				LE-102FBP	LR5-102LJBW		○	○
				LE-202FBP	LR5-202LJBW		○	○
	Pole Mount (L-bracket)	×	LE-302FBP	LR5-302LJBW		○	○	
			LE-402FBP	LR5-402LJBW		○	○	
			LE-502FBP	LR5-502LJBW		○	○	
			LE-102P	LR5-102LJNW		○	○	
			LE-202P	LR5-202LJNW		○	○	
			LE-302P	LR5-302LJNW		○	○	
	100V AC / 220V AC	Direct Mount	○	LE-110FBW / LE-120FBW	LR4-1M2WJBW	Available for φ40 only.	○	×
				LE-210FBW / LE-220FBW	LR4-2M2WJBW		○	×
				LE-310FBW / LE-320FBW	LR4-3M2WJBW		○	×
				LE-410FBW / LE-420FBW	LR4-4M2WJBW		○	×
				LE-510FBW / LE-520FBW	LR4-5M2WJBW		○	×
				LE-110W / LE-120W	LR4-1M2WJNW		○	×
Pole Mount (L-bracket)		○	LE-210W / LE-220W	LR4-2M2WJNW	○		×	
			LE-310W / LE-320W	LR4-3M2WJNW	○		×	
			LE-410W / LE-420W	LR4-4M2WJNW	○		×	
			LE-510W / LE-520W	LR4-5M2WJNW	○		×	
			LE-110FBP / LE-120FBP	LR4-1M2LJBW	Does not comply with Low-voltage Directive (IEC/EN 60947-5-1, EN62471). Available for φ40 only. No CE for M2LJ type.		○	○
			LE-210FBP / LE-220FBP	LR4-2M2LJBW			○	○
LE-310FBP / LE-320FBP	LR4-3M2LJBW	○	○					
LE-410FBP / LE-420FBP	LR4-4M2LJBW	○	○					
LE-510FBP / LE-520FBP	LR4-5M2LJBW	○	○					
LE-110P / LE-120P	LR4-1M2LJNW	○	○					
Pole Mount (L-bracket)	×	LE-210P / LE-220P	LR4-2M2LJNW	○		○		
		LE-310P / LE-320P	LR4-3M2LJNW	○		○		
		LE-410P / LE-420P	LR4-4M2LJNW	○		○		
		LE-510P / LE-520P	LR4-5M2LJNW	○		○		
		LES-102AW	LR5-102WJNW	×		×		
		LES-202AW	LR5-202WJNW	×		×		
LES-A φ50	24V AC/DC	Direct Mount	×	LES-302AW	LR5-302WJNW	×	×	
				LES-402AW	LR5-402WJNW	×	×	
				LES-502AW	LR5-502WJNW	×	×	
		Pole Mount (L-bracket)	×	LES-102A	LR5-102LJNW	○	○	
				LES-202A	LR5-202LJNW	○	○	
				LES-302A	LR5-302LJNW	○	○	
Pole Mount (L-bracket)	×	LES-402A	LR5-402LJNW	○	○			
		LES-502A	LR5-502LJNW	○	○			
		LU5-02FB	LR5-02WJNW	○	×			
LU5 φ50	24V DC	Direct Mount	○	LU5-02	LR5-02WTNW	○	×	
				LU5-02	LR5-02WTNW	○	×	
LME φ60	24V AC/DC	Direct Mount	○	LME-102FBW	LR6-102WJBW		○	×
				LME-202FBW	LR6-202WJBW		○	×
				LME-302FBW	LR6-302WJBW		○	×
				LME-402FBW	LR6-402WJBW		○	×
				LME-502FBW	LR6-502WJBW		○	×
				LME-102W	LR6-102WJNW		○	×
				LME-202W	LR6-202WJNW		○	×
				LME-302W	LR6-302WJNW		○	×
				LME-402W	LR6-402WJNW		○	×
		Pole Mount (Circular-mount Bracket)	○	LME-502W	LR6-502WJNW		○	×
				LME-102FB	LR6-102PJBW		○	×
				LME-202FB	LR6-202PJBW		○	×
				LME-302FB	LR6-302PJBW		○	×
				LME-402FB	LR6-402PJBW		○	×
				LME-502FB	LR6-502PJBW		○	×
				LME-102	LR6-102PJNW		○	×
				LME-202	LR6-202PJNW		○	×
				LME-302	LR6-302PJNW		○	×
Pole Mount (L-bracket)	×	LME-402	LR6-402PJNW		○	×		
		LME-502	LR6-502PJNW		○	×		

LR Series Compatibility Chart (φ60 - φ70)

Current Models					Succeeding Models			
Series	Voltage	Installation Type	Buzzer	Model	Model	Comment	Installation Pitch	Fixed Wiring Hole
LME φ60	24V AC/DC	Pole Mount (L-bracket)	○	LME-102FBL	LR6-102LJBW		○	○
				LME-202FBL	LR6-202LJBW		○	○
				LME-302FBL	LR6-302LJBW		○	○
				LME-402FBL	LR6-402LJBW		○	○
				LME-502FBL	LR6-502LJBW		○	○
		Pole Mount (Wall-mount Bracket)	○	LME-102L	LR6-102LJNW		○	○
				LME-202L	LR6-202LJNW		○	○
				LME-302L	LR6-302LJNW		○	○
				LME-402L	LR6-402LJNW		○	○
				LME-502L	LR6-502LJNW		○	○
	100V AC / 120V AC	Pole Mount (Circular-mount Bracket)	○	LME-110FBW / LME-112FBW	LR6-1M2WJBW		○	×
				LME-210FBW / LME-212FBW	LR6-2M2WJBW		○	×
				LME-310FBW / LME-312FBW	LR6-3M2WJBW		○	×
				LME-410FBW / LME-412FBW	LR6-4M2WJBW		○	×
				LME-510FBW / LME-512FBW	LR6-5M2WJBW		○	×
		Pole Mount (L-bracket)	○	LME-110FB	LR6-1M2PJBW		○	×
				LME-210FB	LR6-2M2PJBW		○	×
				LME-310FB	LR6-3M2PJBW		○	×
				LME-410FB	LR6-4M2PJBW		○	×
				LME-510FB	LR6-5M2PJBW		○	×
220V AC / 230V AC	Pole Mount (Circular-mount Bracket)	○	LME-110FBL / LME-112FBL	LR6-1M2LJBW		○	○	
			LME-210FBL / LME-212FBL	LR6-2M2LJBW		○	○	
			LME-310FBL / LME-312FBL	LR6-3M2LJBW		○	○	
			LME-410FBL / LME-412FBL	LR6-4M2LJBW		○	○	
			LME-510FBL / LME-512FBL	LR6-5M2LJBW		○	○	
	Pole Mount (L-bracket)	○	LME-110L / LME-112L	LR6-1M2LJNW		○	○	
			LME-210L / LME-212L	LR6-2M2LJNW		○	○	
			LME-310L / LME-312L	LR6-3M2LJNW		○	○	
			LME-410L / LME-412L	LR6-4M2LJNW		○	○	
			LME-510L / LME-512L	LR6-5M2LJNW		○	○	
24V DC	Direct Mount	○	LME-120FBW / LME-123FBW	LR6-1M2WJBW		○	×	
			LME-220FBW / LME-223FBW	LR6-2M2WJBW		○	×	
			LME-320FBW / LME-323FBW	LR6-3M2WJBW		○	×	
			LME-420FBW / LME-423FBW	LR6-4M2WJBW		○	×	
			LME-520FBW / LME-523FBW	LR6-5M2WJBW		○	×	
	Pole Mount (Circular-mount Bracket)	○	LME-120	LR6-1M2PJBW		○	○	
			LME-220	LR6-2M2PJBW		○	○	
			LME-320	LR6-3M2PJBW		○	○	
			LME-420	LR6-4M2PJBW		○	○	
			LME-520	LR6-5M2PJBW		○	○	
90 - 250V AC	Direct Mount	○	LME-120W / LME-123W	LR6-1M2WJNW		○	×	
			LME-220W / LME-223W	LR6-2M2WJNW		○	×	
			LME-320W / LME-323W	LR6-3M2WJNW		○	×	
			LME-420W / LME-423W	LR6-4M2WJNW		○	×	
			LME-520W / LME-523W	LR6-5M2WJNW		○	×	
	Pole Mount (L-bracket)	○	LME-120L / LME-123L	LR6-1M2LJNW		○	○	
			LME-220L / LME-223L	LR6-2M2LJNW		○	○	
			LME-320L / LME-323L	LR6-3M2LJNW		○	○	
			LME-420L / LME-423L	LR6-4M2LJNW		○	○	
			LME-520L / LME-523L	LR6-5M2LJNW		○	○	

LR Series Compatibility Chart (φ60 - φ70)

Current Models					Succeeding Models				
Series	Voltage	Installation Type	Buzzer	Model	Model	Comment	Installation Pitch	Fixed Wiring Hole	
LMS φ60	24V AC/DC	Pole Mount (Circular-mount Bracket)	×	LMS-102	LR6-102PJNW		○	×	
				LMS-202	LR6-202PJNW		○	×	
				LMS-302	LR6-302PJNW		○	×	
				LMS-402	LR6-402PJNW		○	×	
				LMS-502	LR6-502PJNW		○	×	
		Pole Mount (L-bracket)	×	LMS-102L	LR6-102LJNW		○	○	
				LMS-202L	LR6-202LJNW		○	○	
				LMS-302L	LR6-302LJNW		○	○	
				LMS-402L	LR6-402LJNW		○	○	
				LMS-502L	LR6-502LJNW		○	○	
LHE-A φ70	24V AC/DC	Direct Mount	○	LHE-102AFB	LR7-102WJBW		○	×	
				LHE-202AFB	LR7-202WJBW		○	×	
				LHE-302AFB	LR7-302WJBW		○	×	
				LHE-402AFB	LR7-402WJBW		○	×	
				LHE-502AFB	LR7-502WJBW		○	×	
	100V AC / 120V AC			○	LHE-102A	LR7-102WJNW		○	×
					LHE-202A	LR7-202WJNW		○	×
					LHE-302A	LR7-302WJNW		○	×
					LHE-402A	LR7-402WJNW		○	×
					LHE-502A	LR7-502WJNW		○	×
220V AC	○	LHE-110AFB / LHE-112AFB	LR6-1M2WJBW		○	×			
		LHE-210AFB / LHE-212AFB	LR6-2M2WJBW		○	×			
		LHE-310AFB / LHE-312AFB	LR6-3M2WJBW		○	×			
		LHE-410AFB / LHE-412AFB	LR6-4M2WJBW		○	×			
		LHE-510AFB / LHE-512AFB	LR6-5M2WJBW		○	×			
		24V DC	○	LHE-110A / LHE-112A	LR6-1M2WJNW		○	×	
				LHE-210A / LHE-212A	LR6-2M2WJNW		○	×	
				LHE-310A / LHE-312A	LR6-3M2WJNW		○	×	
				LHE-410A / LHE-412A	LR6-4M2WJNW		○	×	
				LHE-510A / LHE-512A	LR6-5M2WJNW		○	×	
90 - 250V AC	○	LHE-120AFB	LR6-1M2WJBW		○	×			
		LHE-220AFB	LR6-2M2WJBW		○	×			
		LHE-320AFB	LR6-3M2WJBW		○	×			
		LHE-420AFB	LR6-4M2WJBW		○	×			
		LHE-520AFB	LR6-5M2WJBW		○	×			
LU7 φ70	Direct Mount	○	LU7-02FB	LR7-02WTNW	Purchase LR7-BW additionally.	○	×		
			LU7-02	LR7-02WTNW		○	×		
			LU7-M2FB	LR6-M2WJNW	Purchase LR6-BW additionally for φ60 size.	○	×		
			LU7-M2	LR6-M2WJNW	Available for φ60 only.	○	×		

